



Decontamination

► Of people, vehicles, machinery, equipment

PRODUCTS

- Collapsible Spill Bund DECON
- Decontamination Foot Floor Mats
- Large Surface Folding Pool LARGE
- Large Surface Folding Pool HEAVY DUTY
- Collapsible Flexible Utility Tray FASTER
- Emergency Container EC



Effective decontamination

(e.g. after an intervention during the bird flu epidemic, etc.)

DECONTAMINATION OF PEOPLE — VEHICLES — EQUIPMENT



Spill Bunds for decontamination of people

Catalogue

Detailed information

Web

COLLAPSIBLE SPILL BUND DECON

- ▷ Specially designed for the most effective decontamination of persons
- ▷ Optimized dimensions of 78.7 × 78.7 × 7.9 in, allowing decontamination of a person with outstretched arms
- ▷ Capacity of 171.7 gallons
- ▷ Quick assembly anywhere in the field
- ▷ Shapeable construction enables use in areas with obstacles
- ▷ Side handles for easy handling
- ▷ Side supports for increased stability
- ▷ Drain hole for easier pumping or draining of contaminated materials
- ▷ Temperature range for using the bund: -22 °F to +158 °C
- ▷ For effective decontamination of footwear, Decontamination Foot Floor Mats are recommended

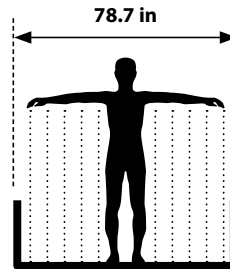
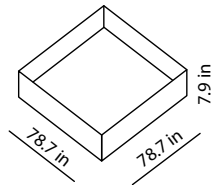

GALLERY



The bund in the transport shape can be carried by one person

Drain hole with cover strip

Detail of the side support for better stability of the bund

Optimised dimensions for decontamination of an individual with outstretched arms



Flexible construction

DECONTAMINATION OF PEOPLE — VEHICLES — EQUIPMENT

DECONTAMINATION FOOT FLOOR MATS

- ▶ Ensure effective and thorough removal of hazardous substances from footwear
- ▶ Made from durable rubber composite based on recycled materials
- ▶ Chemically resistant, non-absorbent surface treatment
- ▶ Heavier weight prevents mats from slipping in the decontamination bund
- ▶ Primarily designed for placement in Collapsible Spill Bunds DECON



Accessories for decontamination of persons

Detailed information



Catalogue



Web

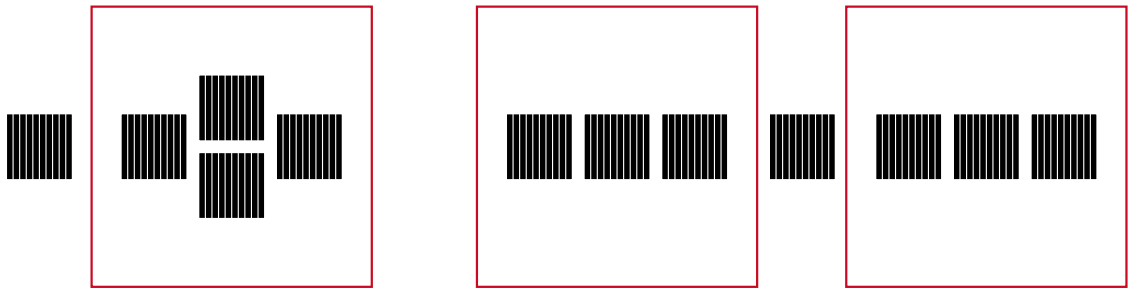

Examples of use

The mats are designed mainly for placement in the Collapsible Decontamination Spill Bunds DECON

GALLERY



Durable reinforced material

The mats have a special surface treatment against water absorption

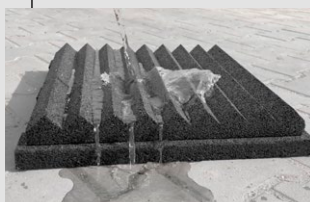

Detail of the surface structure

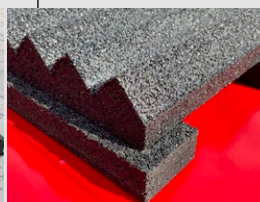

Underside of the mat



Recommended storage method



DECONTAMINATION OF PEOPLE — VEHICLES — EQUIPMENT



Spill Bunds for decontamination of vehicles

Detailed information



Catalogue



Web

LARGE SURFACE FOLDING POOL LARGE

- ▶ Ideal for decontamination or washing of all vehicle types, including vans, trucks, tankers, etc.
- ▶ Easy entry and exit due to folding side walls
- ▶ Made from chemically resistant material
- ▶ Constructed from strong PVC with a protective pad under the bottom to ensure extended durability
- ▶ Custom dimensions available upon customer request
- ▶ Also suitable for preventing leaks during vehicle refueling or repairs

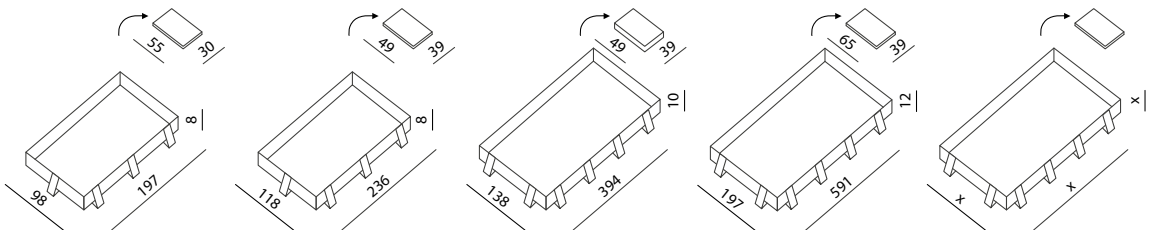

GALLERY



Instructions for use



Decontamination/washing of a vehicle



Examples of use

Drive in through open side wall on under-wheel tracks

Use for washing or decon. of vehicles

Possibility of adding a drain hole and ball valve

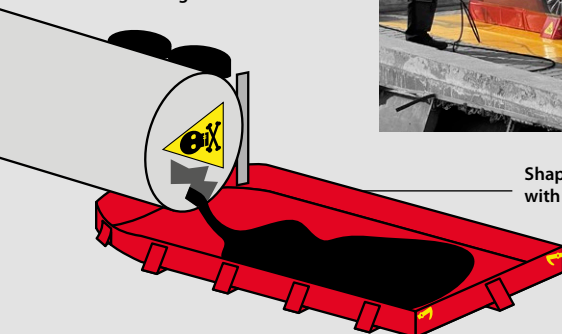
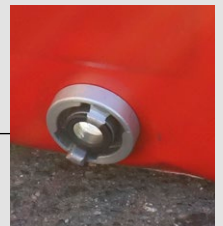

Shapeable construction with folding side supports

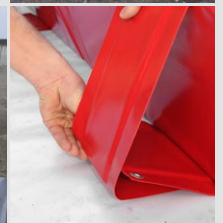
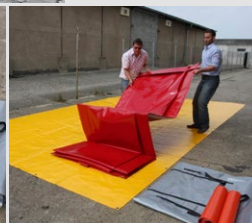

DECONTAMINATION OF PEOPLE

VEHICLES

EQUIPMENT



Spill Bunds for decontamination of vehicles

Detailed information



Catalogue

Web



LARGE SURFACE FOLDING POOL HEAVY DUTY

- Extremely durable spill bund suitable for washing or decontaminating heavy-duty military and fire-fighting vehicles, including tracked vehicles, tanks, and high-load vehicles
- Constructed from extra-strong, chemically resistant PVC
- Folding sidewalls allow easy entry and exit
- Equipped with protective pads, an insert, and entry tracks, preventing damage even in rough or rocky terrain
- Custom sizes available to meet individual customer requirements

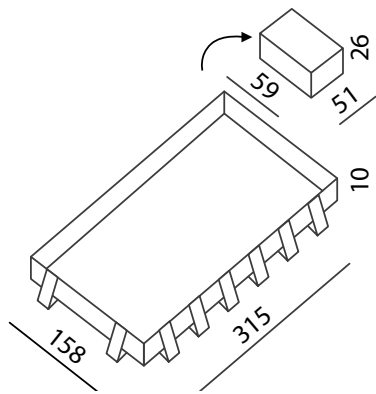

Dimensional ratio of staggered and folded tank

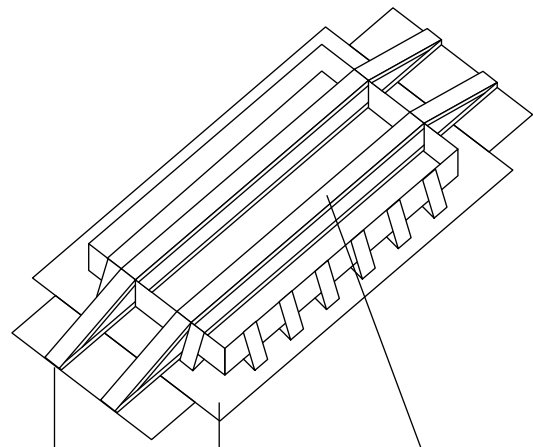

Protective pad from nonwoven fabric

Protective pad made of strong PVC

Wooden ramp

GALLERY



Example of use

Drive-thru spill containment berm with wooden ramps



Detail of anchorage of a wooden ramp



Detail of side supports



Detail of tracked vehicle entering the wooden ramp



DECONTAMINATION OF PEOPLE — VEHICLES — EQUIPMENT



Spill Bunds for decontamination of equipment

Catalogue

Detailed information

Web

COLLAPSIBLE FLEXIBLE UTILITY TRAY FASTER

- ▶ Designed for capturing leaking hazardous substances, degreasing, cleaning, washing or decontaminating machines, tools or equipment
- ▶ Roll-up structure secured with a strap for easy storage
- ▶ Available with solid and segmented reinforcements that adapt better to obstacles in the area of use
- ▶ Available in a wide range of size variants from 5 to 77 gallons
- ▶ Resistant to acids, alkaline substances, petroleum products, and other hazardous materials
- ▶ Can be manufactured from materials with special properties (e.g. antistatic, non-flammable)

Use e.g. for washing, cleaning or decontamination of tools, instruments, spare parts, etc.

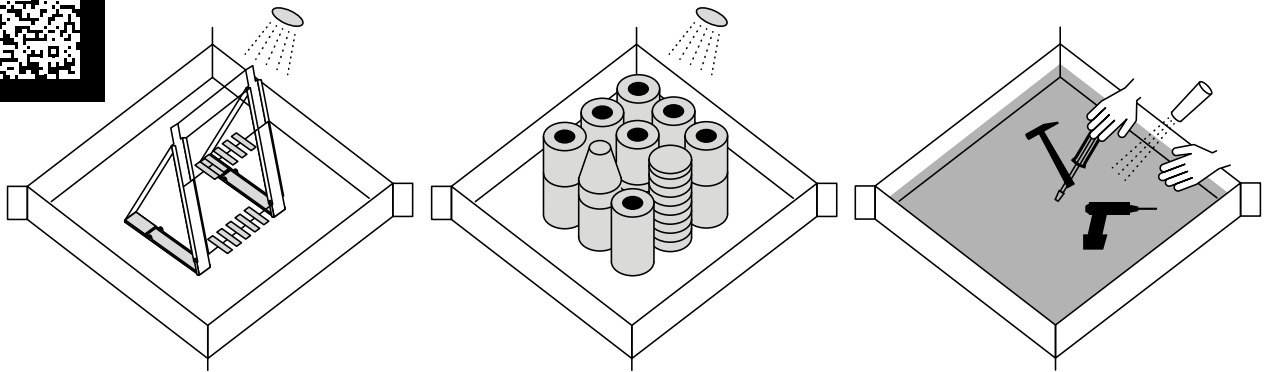

GALLERY



Examples of use

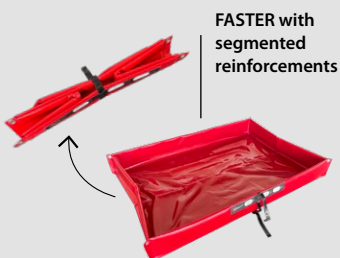

DECONTAMINATION OF PEOPLE — VEHICLES — EQUIPMENT



Emergency containers

EMERGENCY CONTAINER EC

- ▶ Simple tray for contaminated waste (solid and liquid)
- ▶ Low cost enables single-use and disposal of the tray together with the waste
- ▶ Foldable design minimizes storage space
- ▶ Quick assembly without tools or additional accessories

i
Detailed information

Catalogue

Web



EC 02 – constructed with regard to sizes of ADR sets (maximal volume 0.8 gal)

GALLERY



EC 02 in unfolded shape

Examples of use

Its bent edges serve as handles during manipulation

